



**Queen's University
Belfast**



Spectral models of wave energy converters

Matt Folley

Wave energy industry is entering a new phase of development

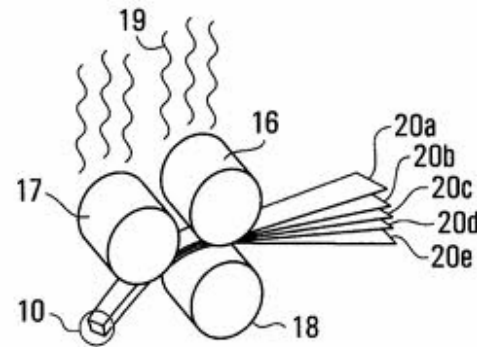

Current numerical modelling tools

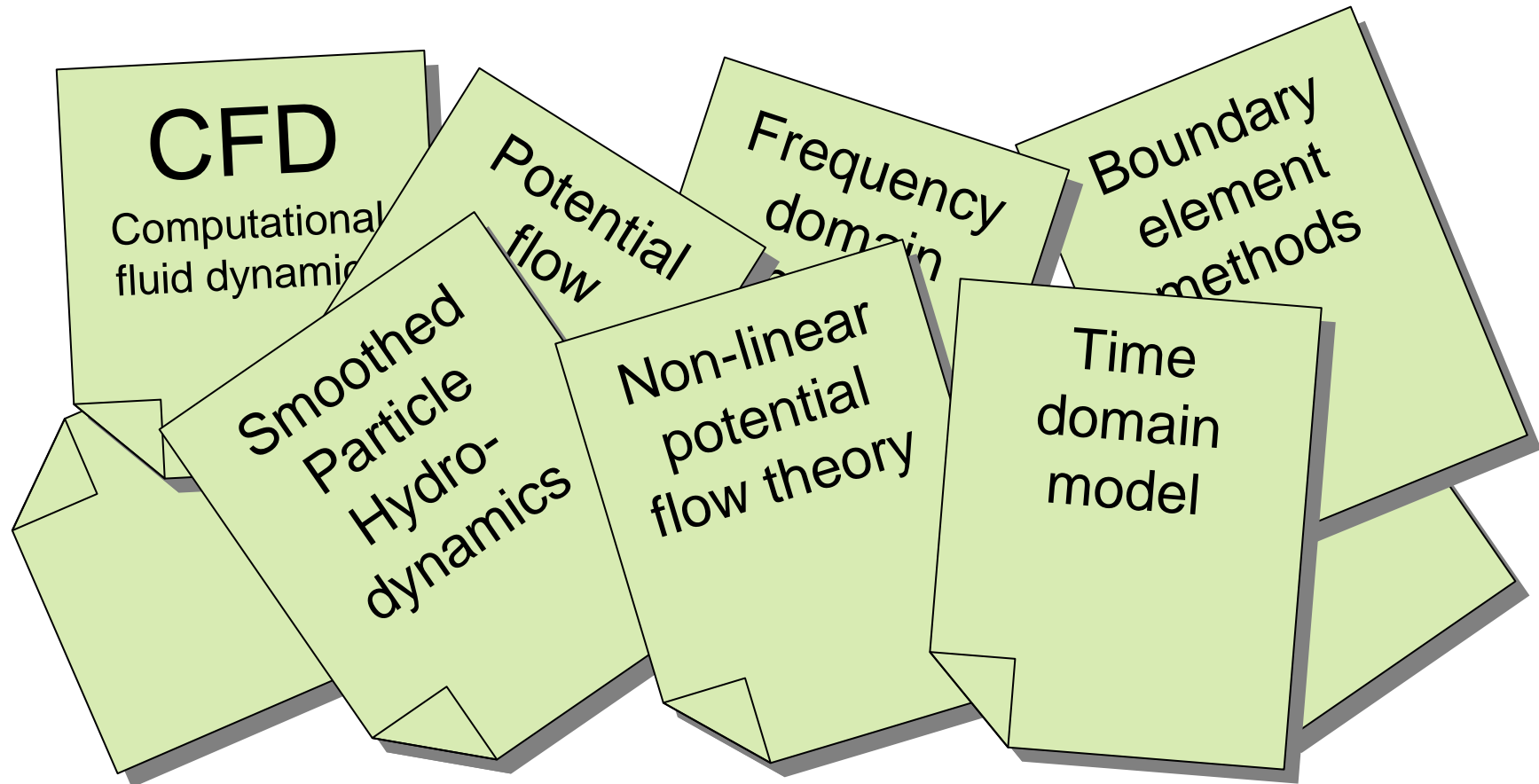

are unsuitable for wave farms

Spectral modelling is a new tool

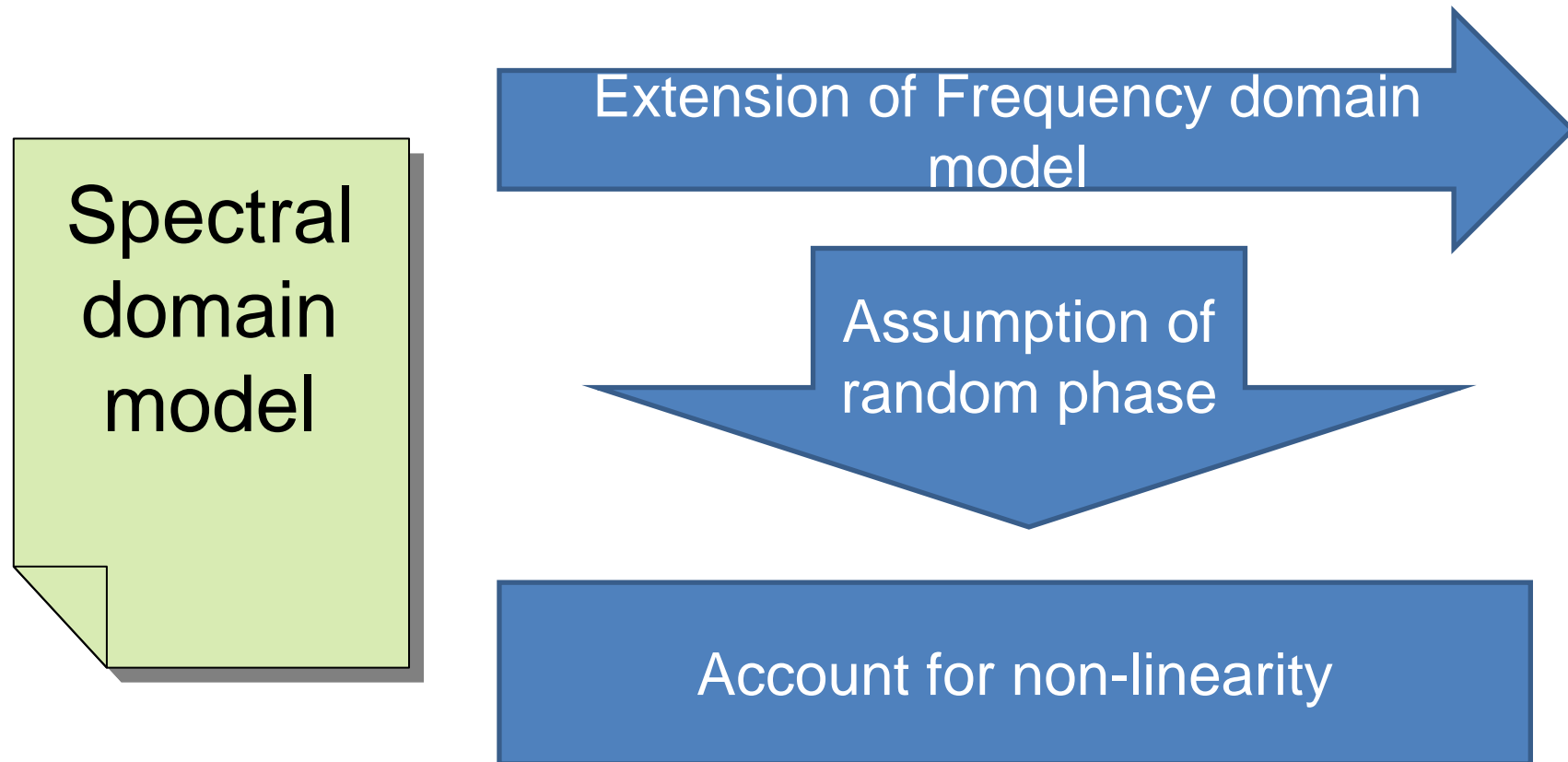

suitable for wave farms

Current tool: Frequency domain

- Harmonic analysis
- Linear

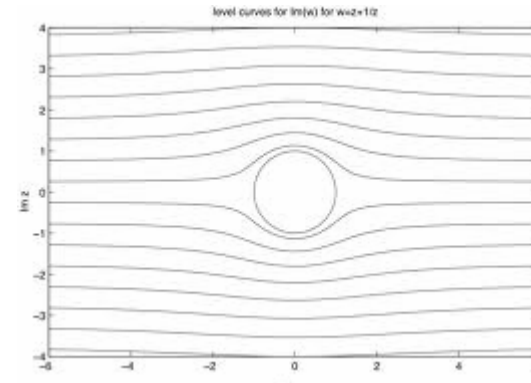
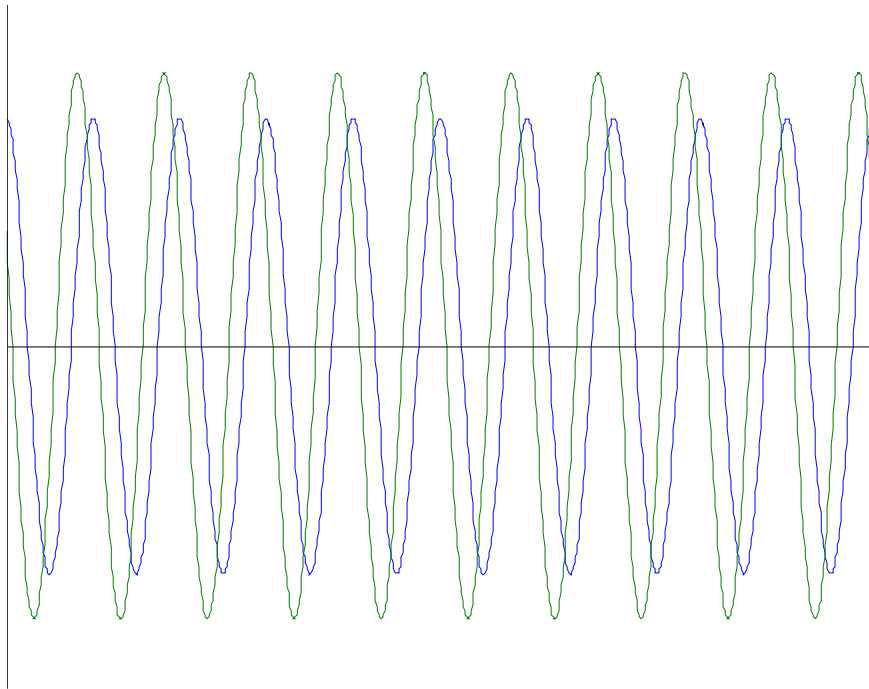

- Fundamental understanding 
- Accurate 



Current tool: Time domain

- Time-marching
- Non-linear

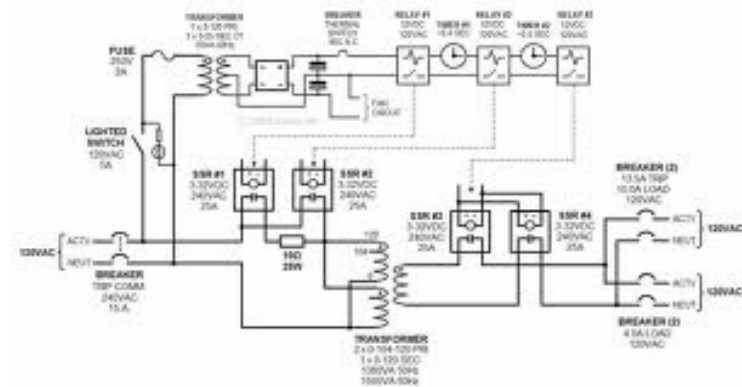
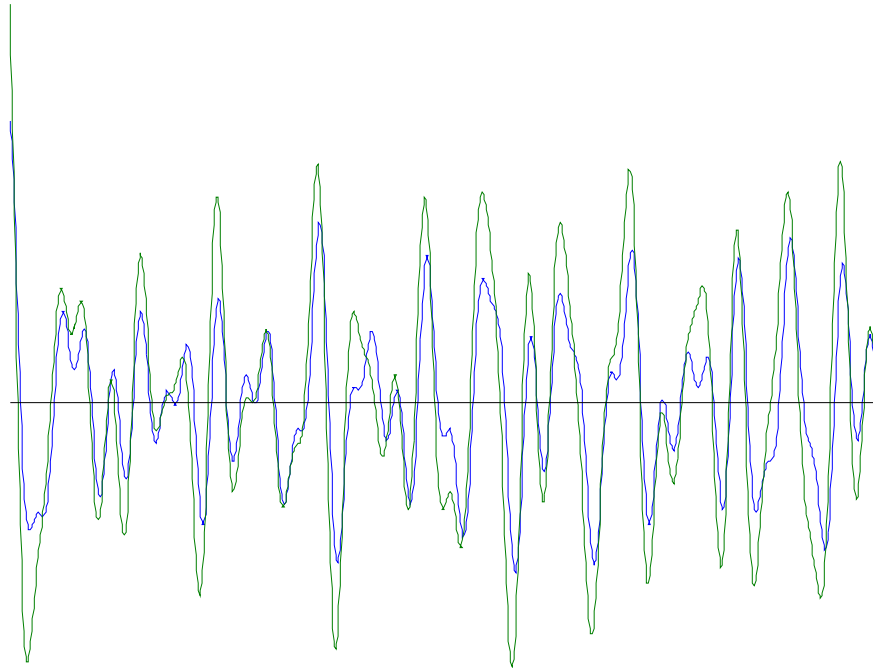

- Accurate



- Computationally Efficient





New tool: Spectral domain

- **Statistical analysis**
- **Non-linear**

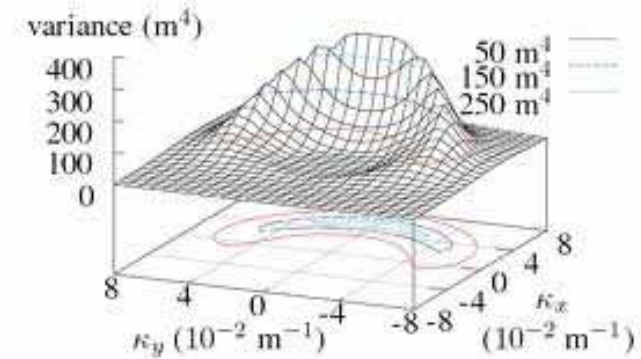
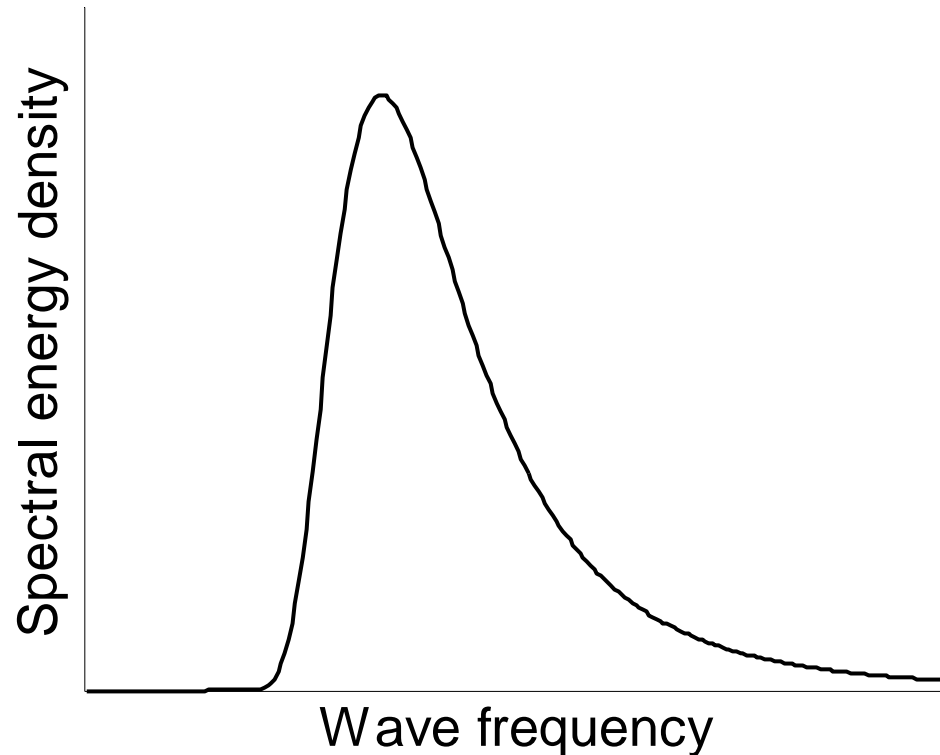



New tool: Spectral domain

- **Statistical analysis**
- **Non-linear**

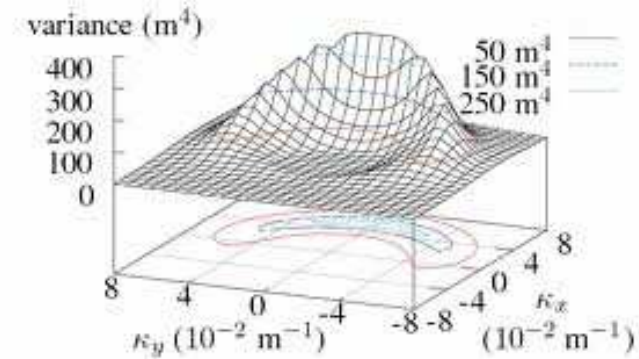
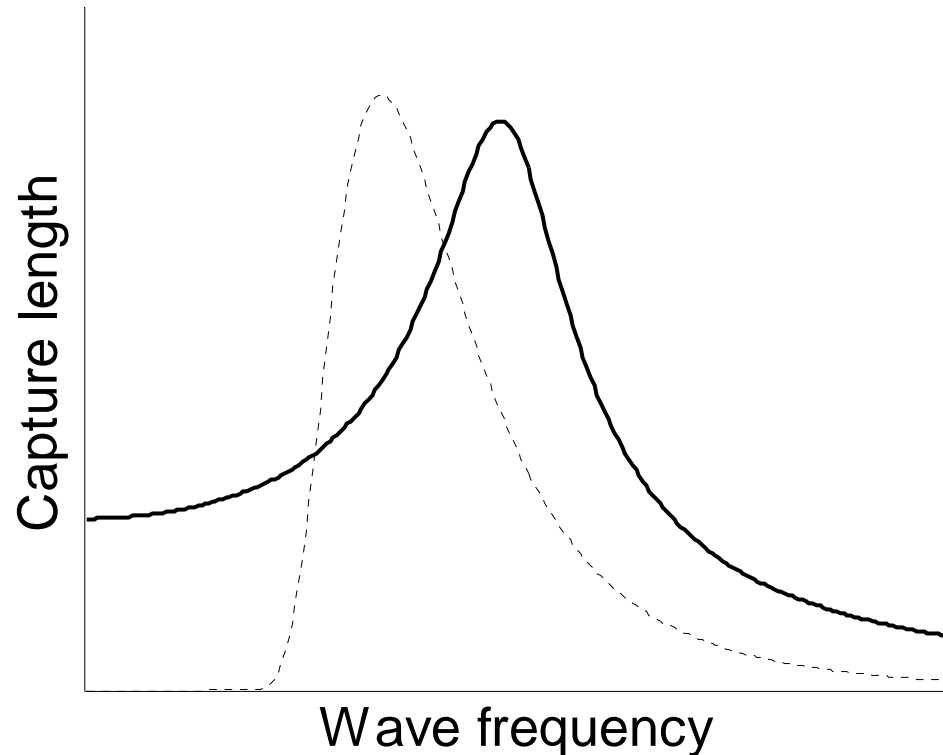



New tool: Spectral domain

- **Statistical analysis**
- **Non-linear**

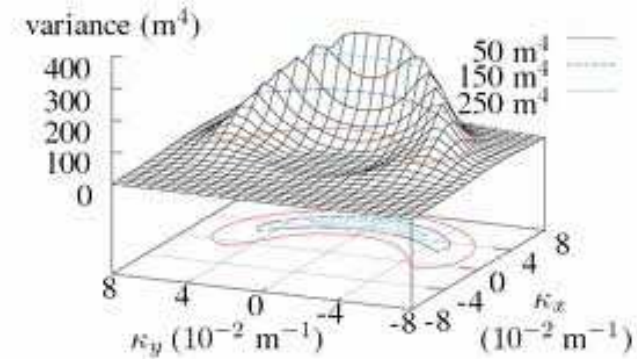
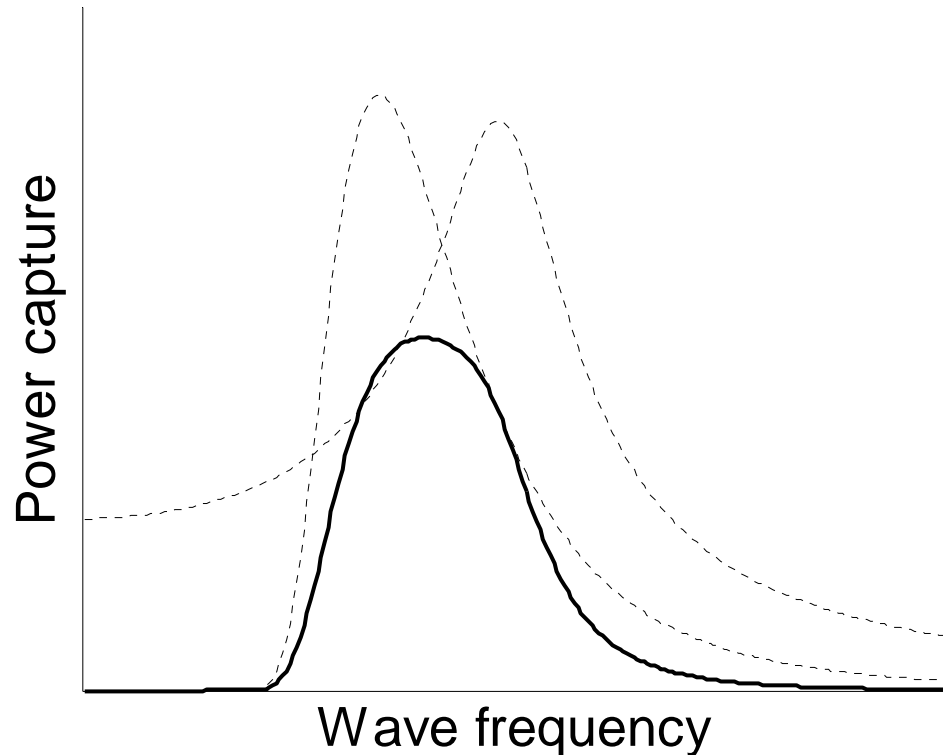

New tool: Spectral domain

- **Statistical analysis**
- **Non-linear**

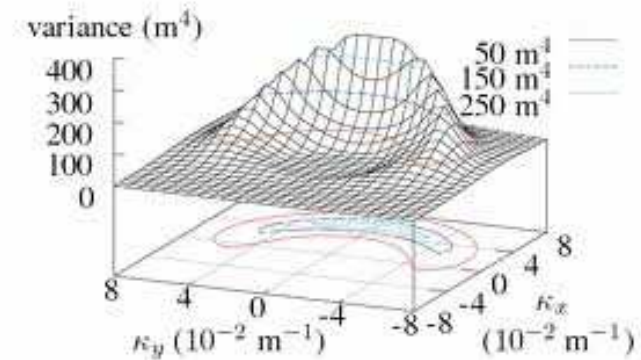
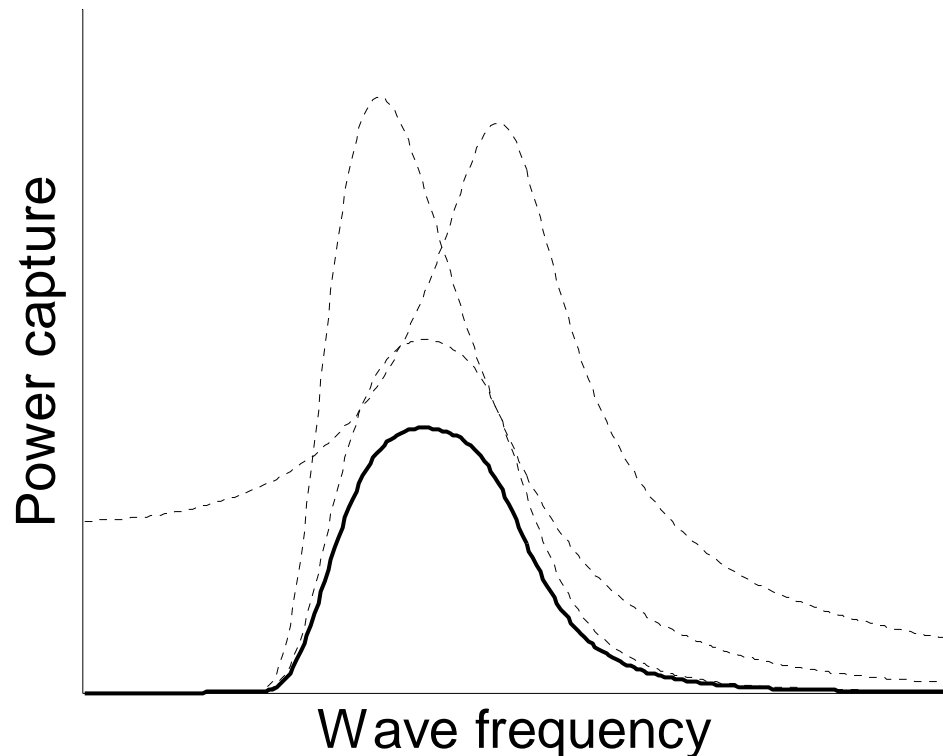

- **Accurate**



- **Computationally Efficient**





Validity of spectral model

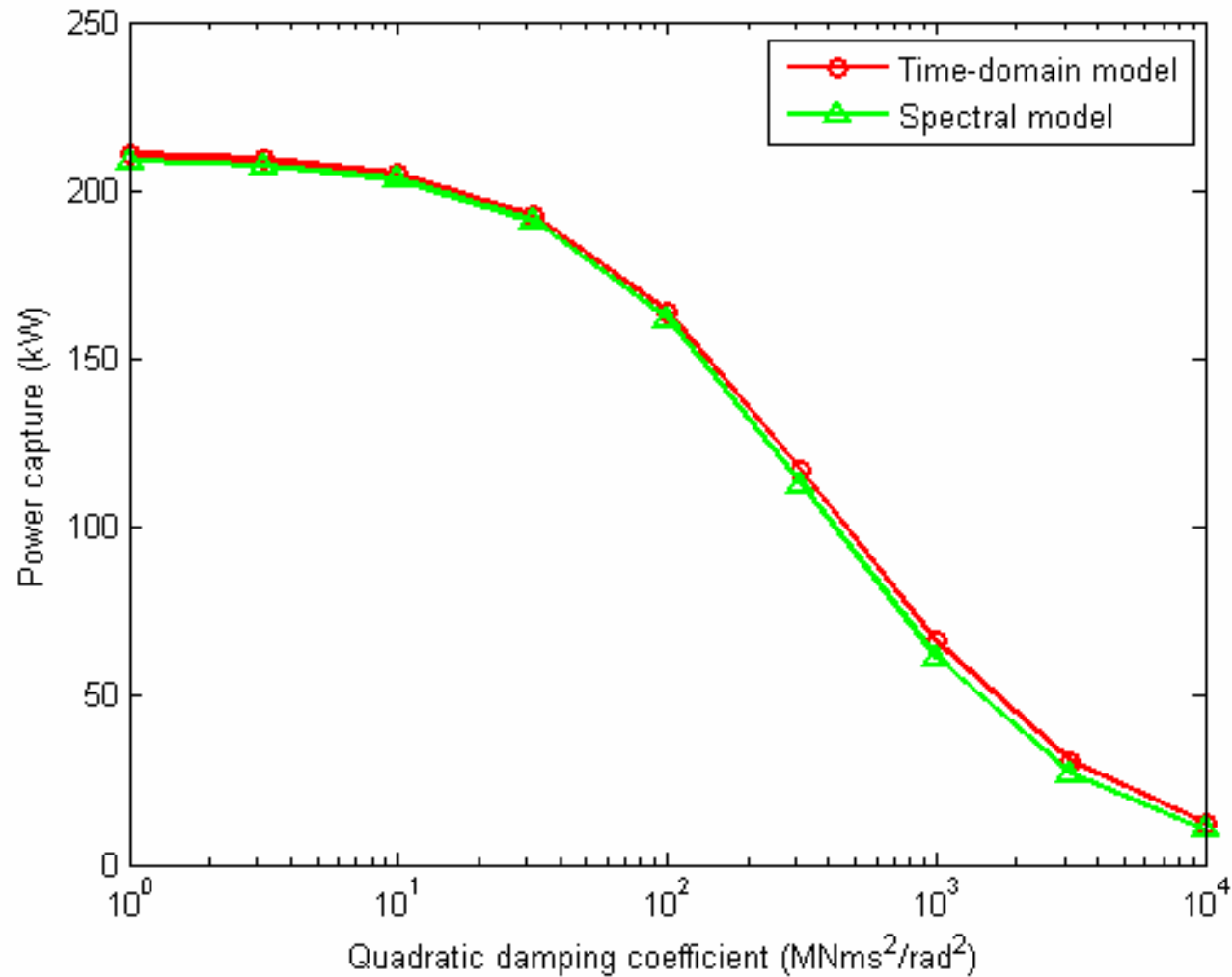

Spectral models of wave farms

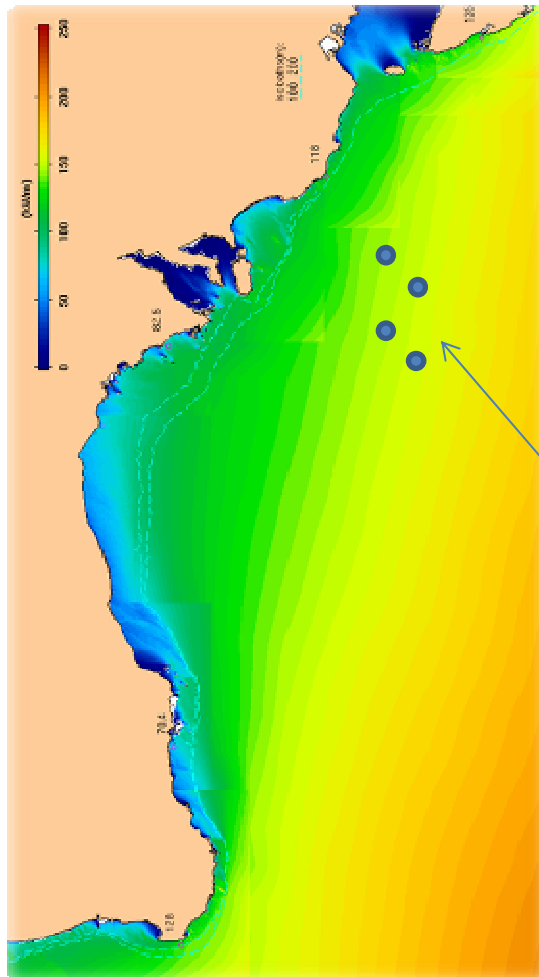

Spectral wave models
SWAN, TOMAWAC, Mike21SW

Phase-averaged model?

Wave energy converters
represented as source
terms

Example device source term function

$$S(\omega, \theta) = \left(\Psi(\omega, \theta) - \langle 2C_d |U| \rangle \right) \cdot a(\omega, \theta)^2$$



Significance of phase

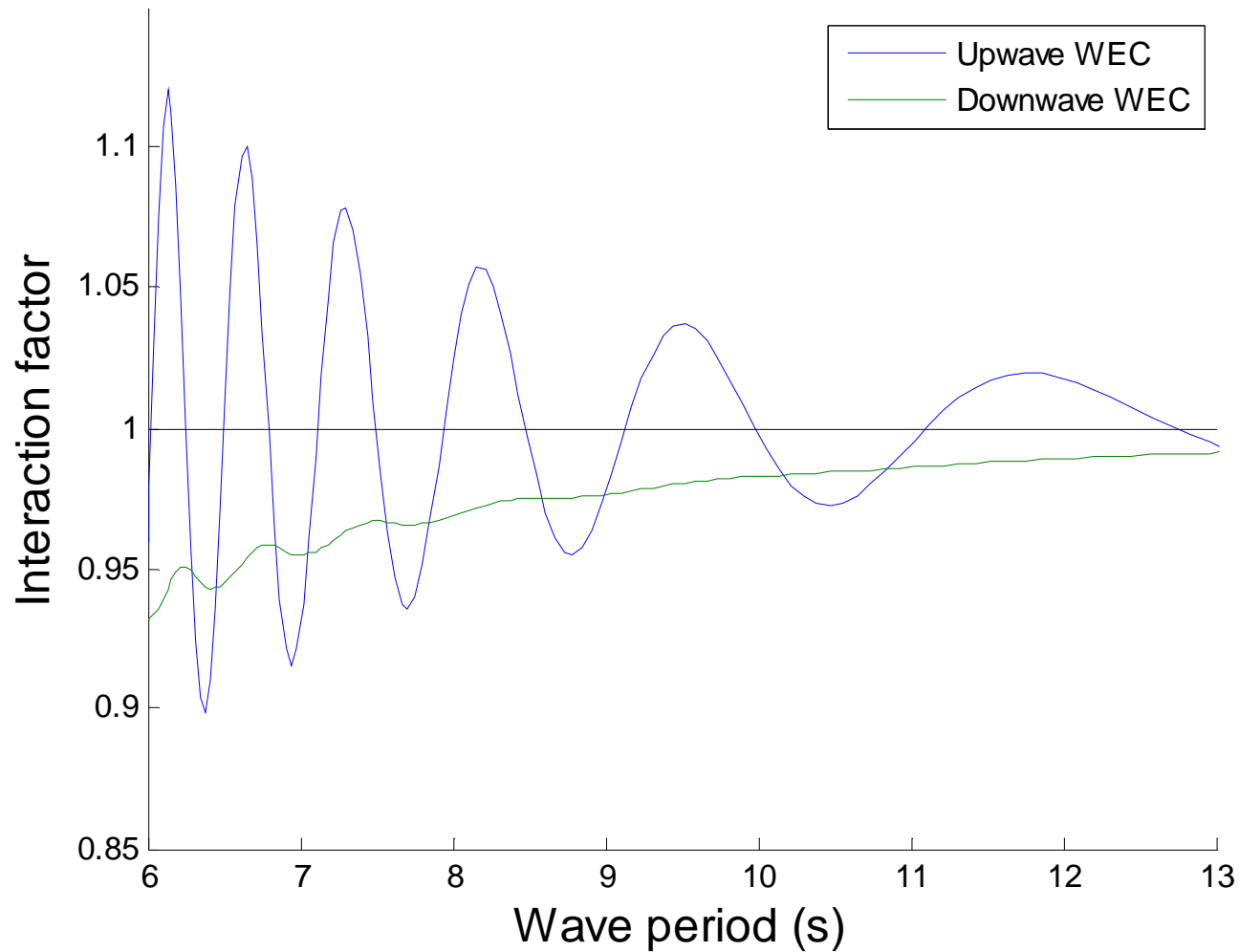



Significance of phase

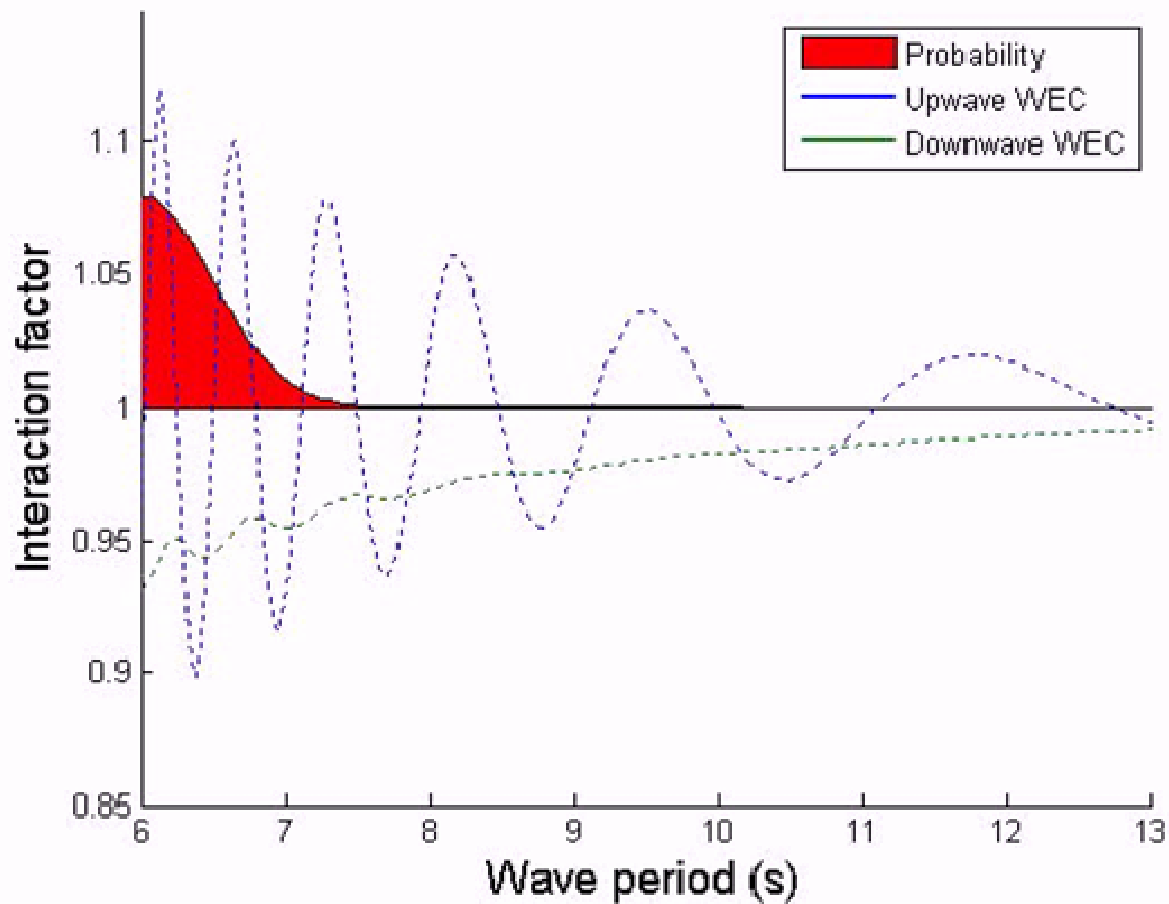



Significance of phase

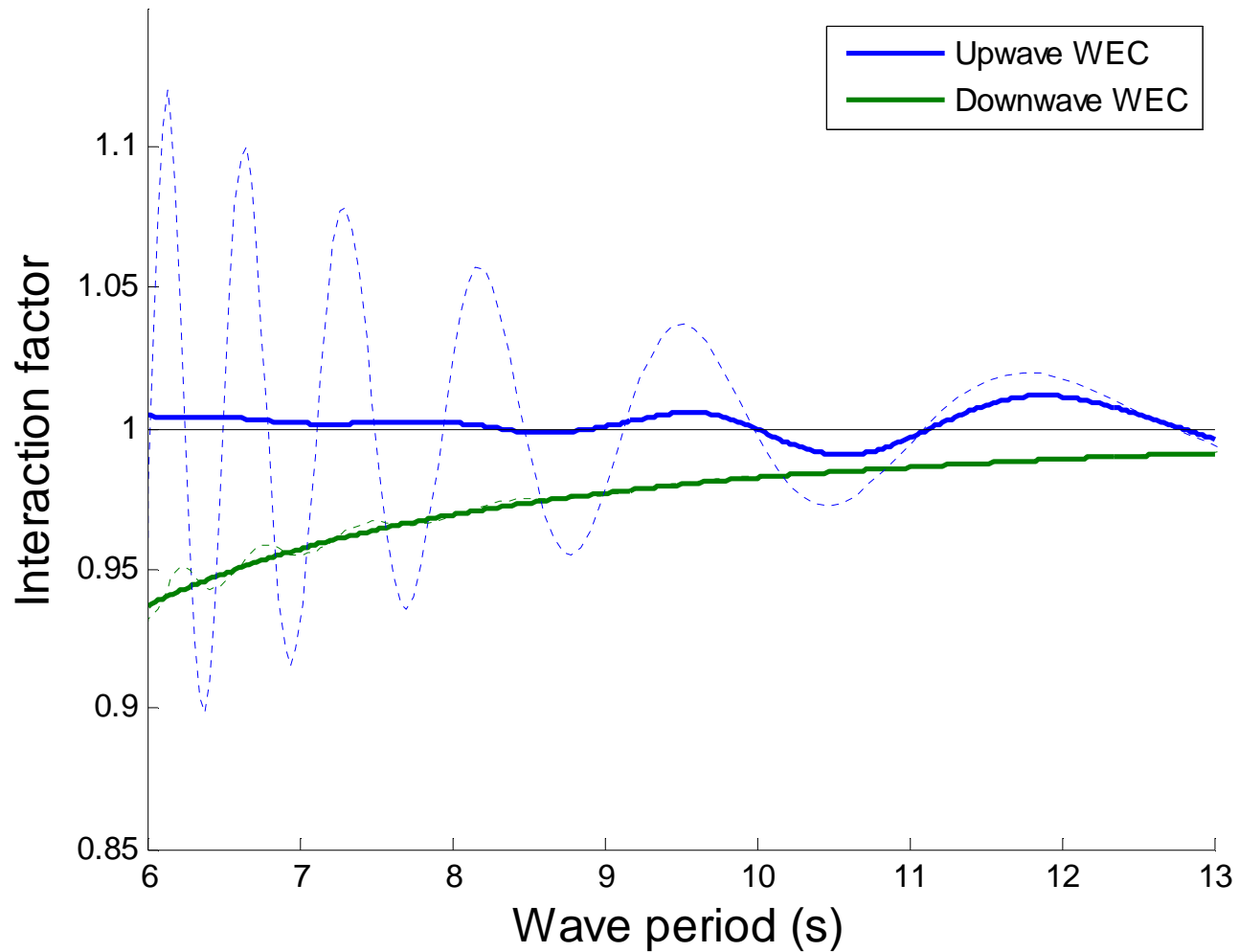



Queen's University
Belfast



Spectral domain modelling

A new tool for wave farms

Accurate

Efficient

Flexible